

IMPORTANT NOTE:

Do not tighten all screws/bolts until all completely assembled.
Thank you.

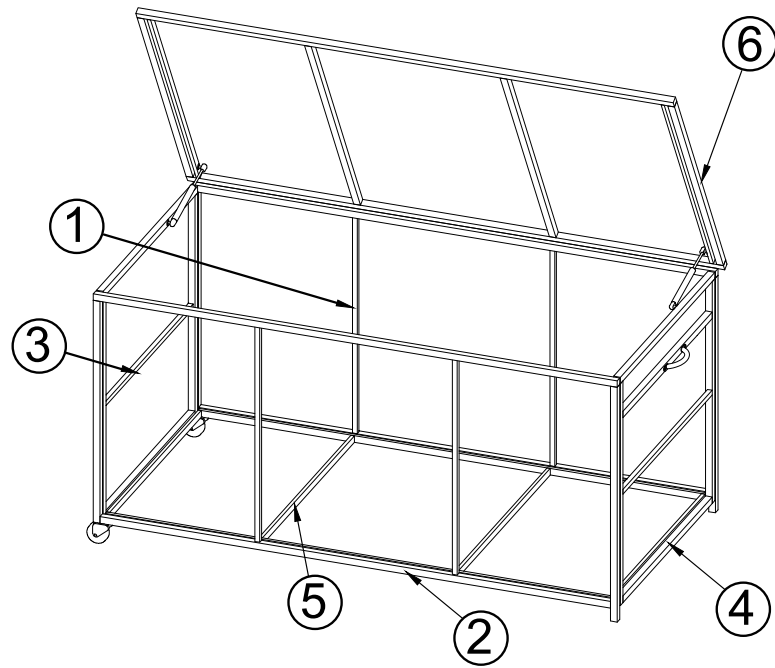

① x1 PCE

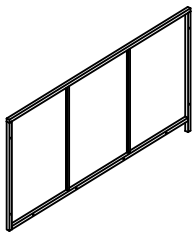

② x1 PCE

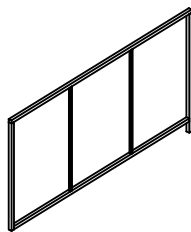

③ x1 PCE

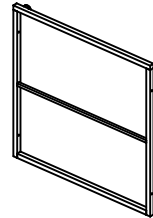

④ x1 PCE

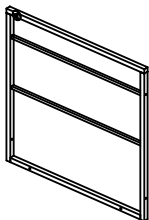

⑤ x1 PCE

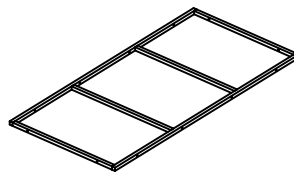

⑥ x1 PCE

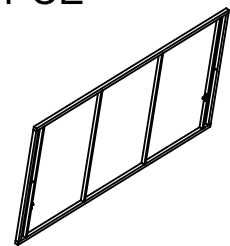

A x1 PCE



Alenkey 4x90mm

Bx30 PCS

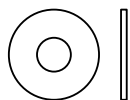

Ø6 x16mm

Cx16 PCS

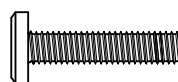

M6 x 35mm

Dx14 PCS



M6 x 15mm

E x1 PCS

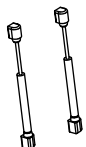

F x1 PCE



G x2 PCS



H x1 PCE

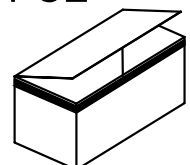

IMPORTANT NOTE:

Do not tighten all screws/bolts until all completely assembled.
Thank you.

STEP 1

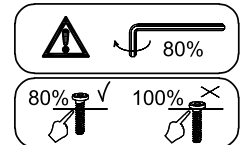
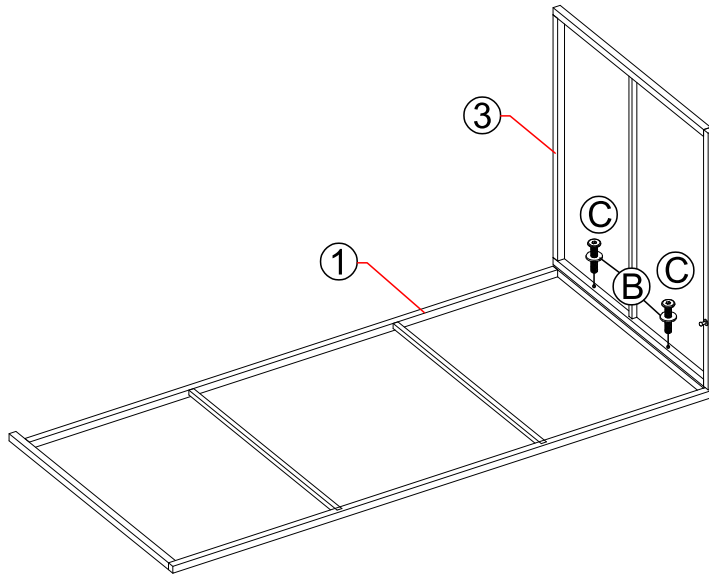

STEP 2

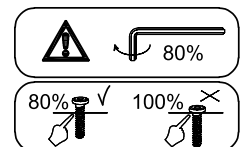
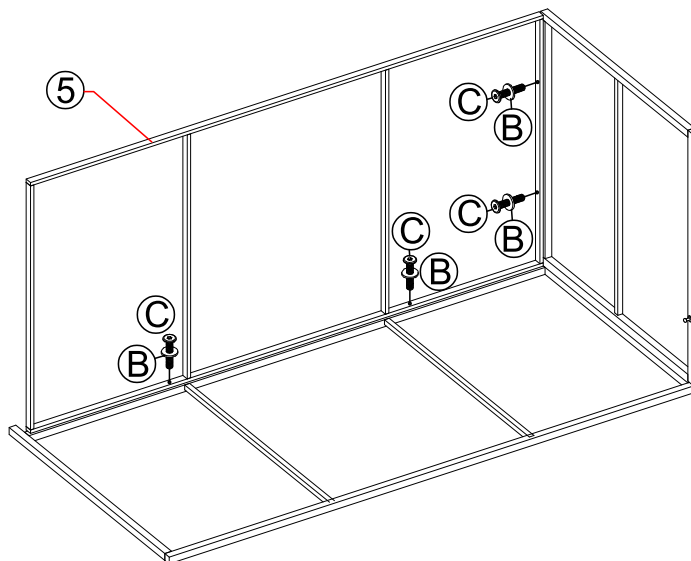

STEP 3

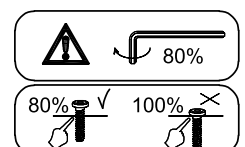
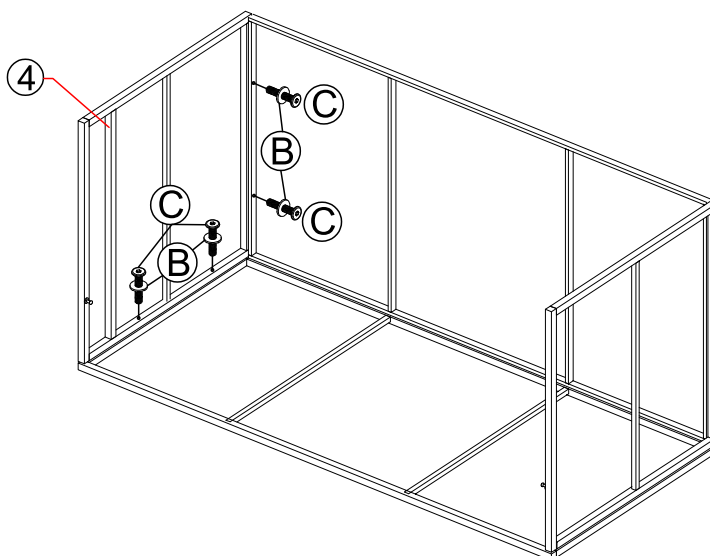

IMPORTANT NOTE:

Do not tighten all screws/bolts until all completely assembled.
Thank you.

STEP 4

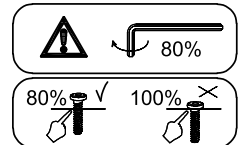
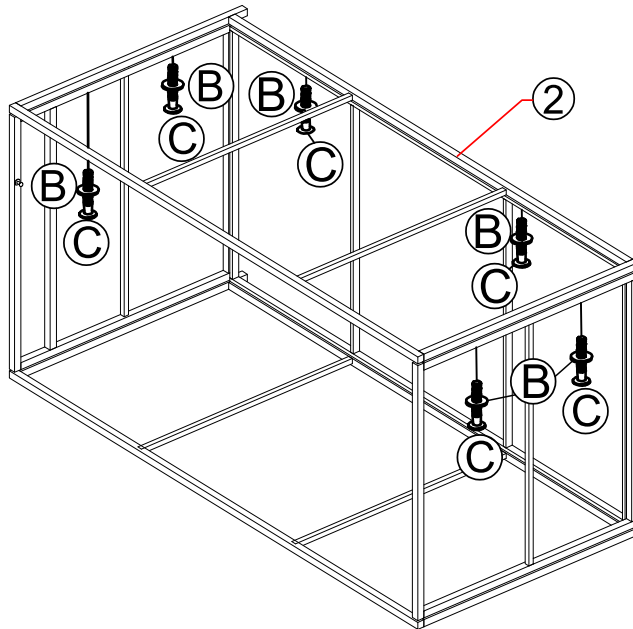

STEP 5

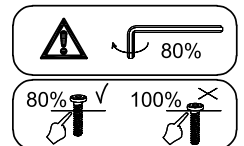
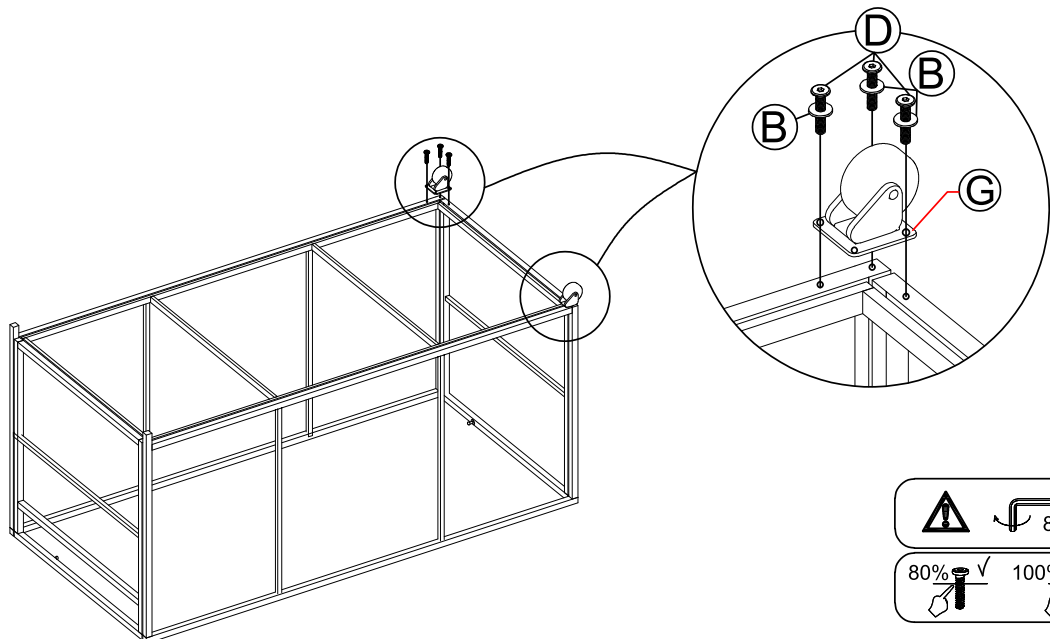

STEP 6

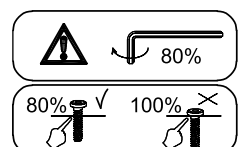
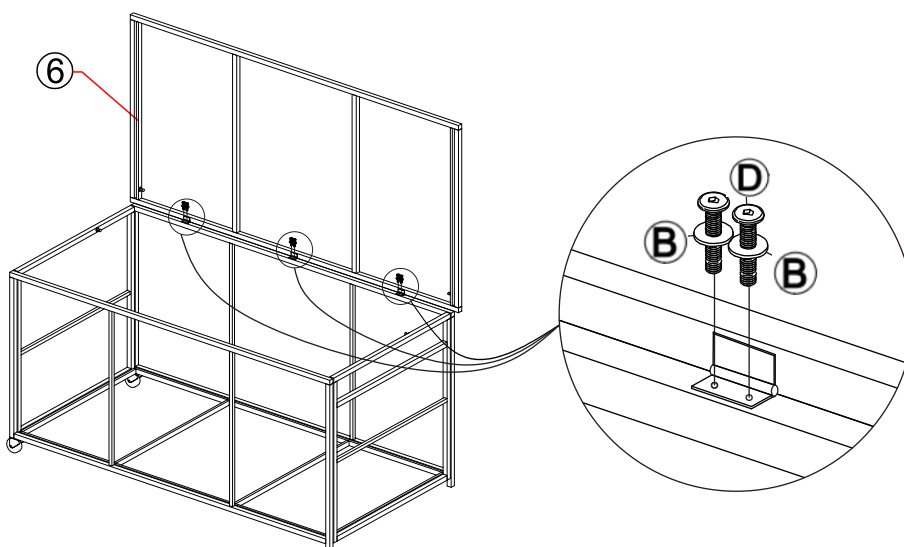

IMPORTANT NOTE:

Do not tighten all screws/bolts until all completely assembled.
Thank you.

STEP 7

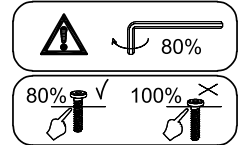
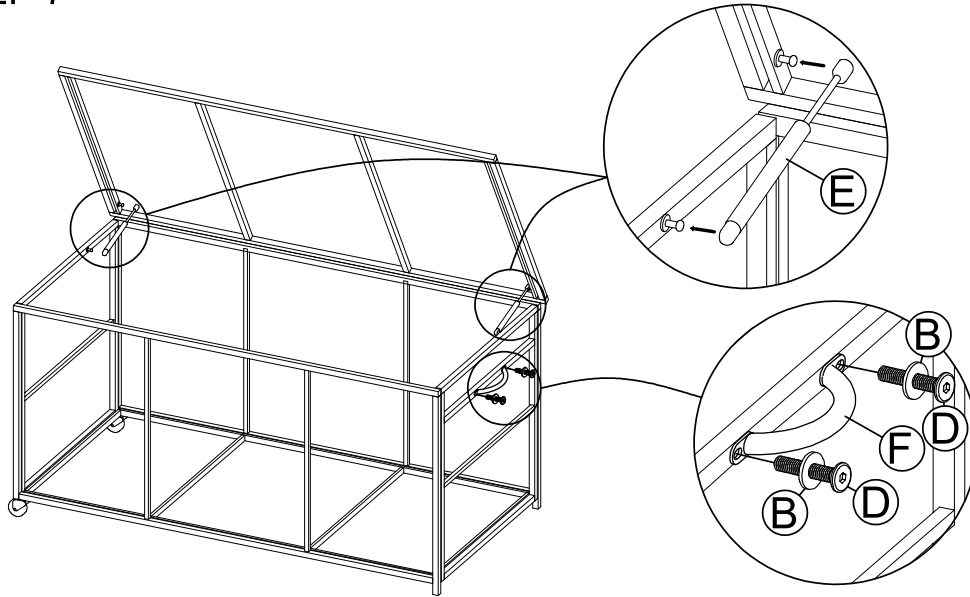

STEP 8

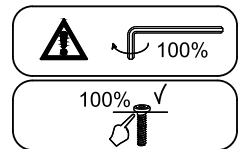
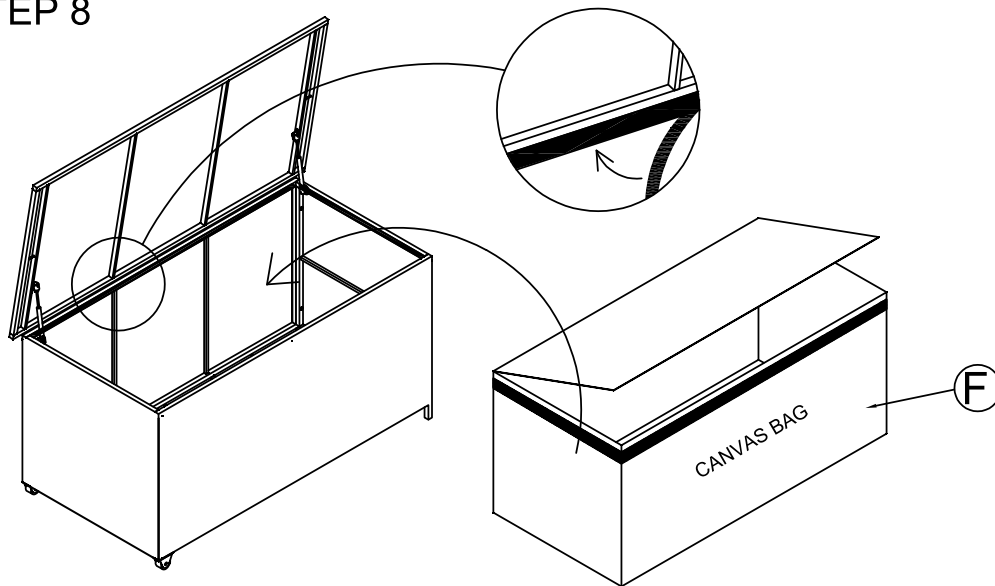

STEP 9

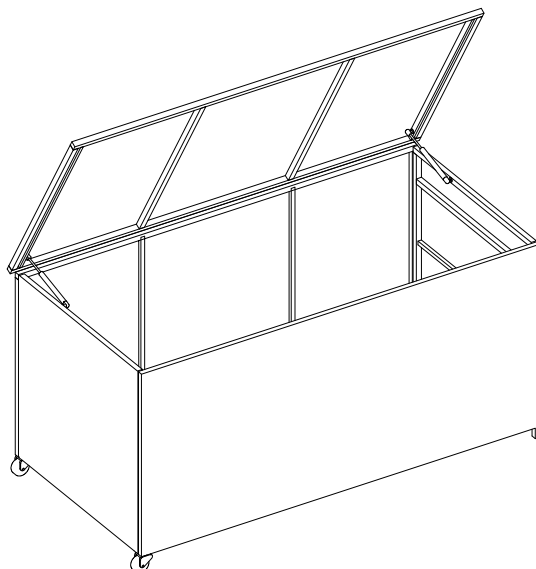

IMPORTANT NOTE:

Do not tighten all screws/bolts until all completely assembled.
Thank you.

Finished